

ALUMINUM CHANNEL PLATFORM TRUCK-SDD-3672

APPROX WEIGHT: 124.10 lbs. DOES NOT INCLUDE WEIGHT OF POWER OR PACKAGING!!!

ANY ADDITIONS, DELETIONS, OR OMISSIONS MUST BE CORRECTED ON THIS DRAWING AS THIS DRAWING WILL BE CONSIDERED ALL INCLUSIVE

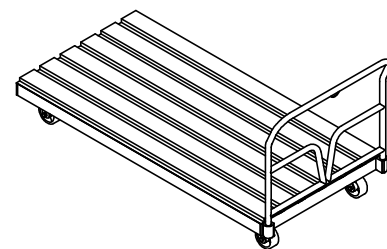
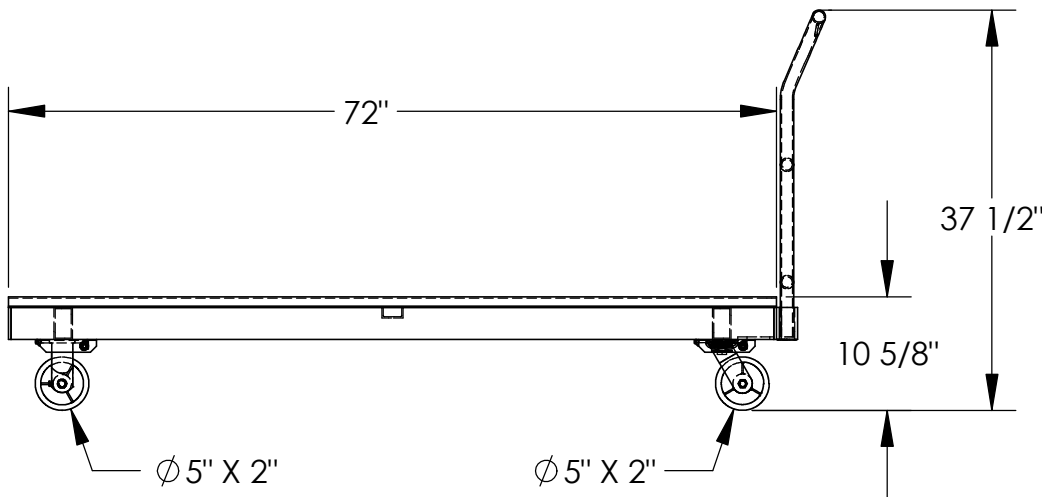
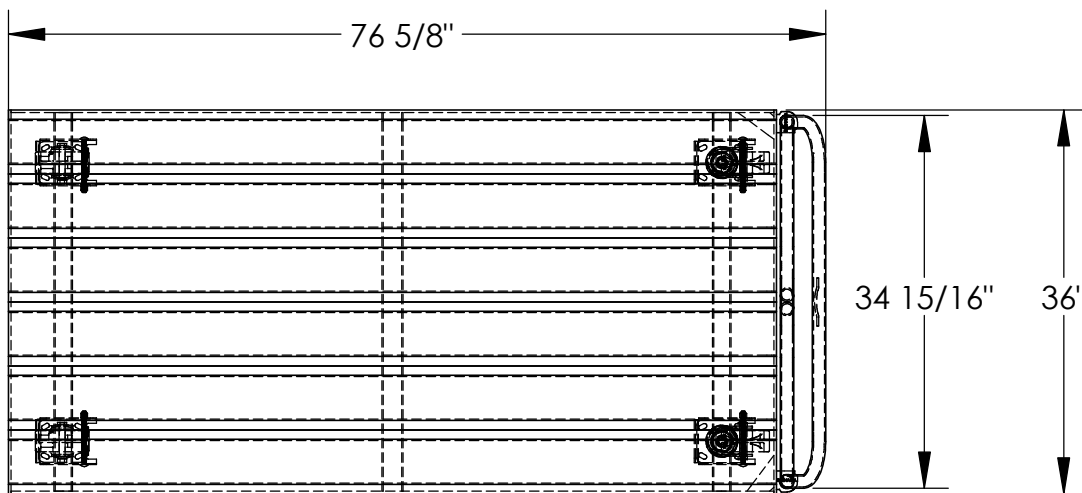

3D VIEW SHOWN FOR REFERENCE ONLY

FOR INTERNAL USE ONLY PROJECT SIGN OFF	
SALES	
ENG.	
FAB.	
POWER	

STANDARD FEATURES

- MODEL NUMBER IS SDD-3672
- UNIFORM CAPACITY IS 3600 LBS.
- OVERALL WIDTH IS 36"
- USABLE WIDTH IS 36"
- OVERALL LENGTH IS 76 5/8"
- USABLE LENGTH IS 72"
- OVERALL HEIGHT IS 37 1/2"
- PLATFORM HEIGHT IS 10 5/8"
- (2) Ø5 X 2 POLY-ON-STEEL SWIVEL CASTERS
- (2) Ø5 X 2 POLY-ON-STEEL RIGID CASTERS
- HANDLE WIDTH IS 34 15/16"
- ALUMINUM CONSTRUCTION

SPECIAL FEATURES

NONE

ALL GRAPHICS PROVIDED ARE FOR REFERENCE ONLY. IF CERTAIN DIMENSIONS ARE CRITICAL PLEASE VERIFY THOSE DIMENSIONS WITH YOUR SALESPERSON

APPROVAL	I, THE UNDERSIGNED, AGREE THAT THE PRODUCT AS REPRESENTED SATISFIES DESIGN AND DIMENSION REQUIREMENTS. I ALSO ACKNOWLEDGE MY DUTY TO CONFIRM PRODUCT AND INSTALLATION COMPLIANCE WITH ALL APPLICABLE FEDERAL, STATE AND LOCAL REGULATIONS AND STANDARDS.	
	ANY MODIFIED UNITS ARE NON-RETURNABLE	
	[] As drawn [] As marked	
	Signed: _____	Date: _____
Printed Name: _____		
LEAD TIME WILL START UPON RECEIPT OF SIGNED APPROVAL DRAWING		

DISTRIBUTOR'S NAME: HOF EQUIPMENT COMPANY PH: 888-990-1150		P.O.# X
DRAWN BY: ND		W.O.# X
DATE: 12/21/05	SALES: X	FILE NAME:
REFERENCE: X	SCALE: 1:18	33-007-041
QUOTED LEAD TIME: X	QUOTE # X	