

- This manual should surely be handed over to users / operators.
- Users / operators should thoroughly read this manual.

No.2



INSTRUCTION MANUAL

(GE type) GEARED TROLLEY to be connected to Electric Hoist
 (G type) GEARED TROLLEY to be connected to Manual Hoist
 (PE type) PLAIN TROLLEY to be connected to Electric Hoist
 (αP type) PLAIN TROLLEY to be connected to Electric Hoist
 (P type) PLAIN TROLLEY to be connected to Manual Hoist

- Thank you for purchasing our Manual Trolley.
- Please read this manual carefully and familiarize yourselves with the details of operation.
- This manual should be kept close to the Manual Trolley because the maintenance and inspection works require it.
- For inspection that requires overhauling, please consult your nearest distributor of our products.

I) NOTES TO USERS FOR SAFETY

Improper operation of Geared Trolley or Plain Trolley(hereafter called "Trolley") will probably cause a dangerous situation such as falling of lifted loads. Carefully read this manual for proper operation before setting-up, installation, operation, maintenance and inspection of Trolley. Do not operate Trolley before you have got familiar with its knowledge, safety information and all the special points of care.

In this manual, care is classified into two levels as follows:

WARNING	This symbol is used to indicate that death or serious injury will probably be caused to the user or persons around when the product is improperly used.
CAUTION	This symbol is used to indicate that damage may be caused to the user or persons around or only material loss will occur when the product is improperly used.

Even the matters indicated **CAUTION** may bring a serious result depending on the situation. Strictly observe the above two kinds of care as they contain very important matters.

This manual must be kept in place where the operator can read it whenever he/she needs.

EXAMPLES OF THE SYMBOL:



△ mark indicates that there are warning / cautionary matters. In the sketch a concrete warning / caution is described.

("Take care not to have your hands caught" CAUTION in the case of the symbol on the left.)



⊘ mark indicates actions prohibited. In the sketch or nearby a concrete prohibited matter is described.

ⓘ mark indicates that any action is forced or instructed. In the sketch or nearby concrete instructions are described.

("General duties for operators" in the case of the symbol on the left.)

1. GENERAL

WARNING	<ul style="list-style-type: none"> ● Trolley should be operated only by those who are familiar with the contents of the manual and instruction labels. 		
<ul style="list-style-type: none"> ● Do not lift loads which exceed the rated load. Never overload. ● Do not operate Trolley when somebody stays in an area where a suspended load is moved. Do not move a load over or above persons. ● Do not use Trolley which was damaged or causes abnormal sound. ● Attach a stopper to the end of the traverse and travel rails. ● Do not use Trolley for oblique pulling. ※ First move Trolley to right over a load and then lift it. ● Make sure that a location on which Trolley is installed has a sufficient strength. (Examples: buildings, rails, beams, etc.) ● Never make modifications to Trolley or its accessories. ● Do not use Trolley for other ways or purposes than connecting to a chain hoist (manual or electric). 			
<ul style="list-style-type: none"> ● Before use, please also read the instruction manual for the chain hoist (manual or electric) to be connected to Trolley. 			

2. INSTALLATION AND SETTING-UP

WARNING	<ul style="list-style-type: none"> ● Inspection before operation and periodic inspection must be by all means carried out. ● The installation work should be performed only by the specialized contractor or experienced technician. 	
<ul style="list-style-type: none"> ● Do not install Trolley in improper places such as exposed to rain or water or other hazards. 		

3. OPERATION AND HANDLING

WARNING	<ul style="list-style-type: none"> ● Do not get on a suspended load. Do not use Trolley to lift, support or transport persons. ● Do not leave a suspended load unattended. 	
<ul style="list-style-type: none"> ● Do not divert your attention from the suspended load. ● Do not use Trolley for the earth lifting (for example, getting the hoist hook to a structure). ● Make sure before operation that the hand chain properly functions. If not, do not operate Trolley. 		
CAUTION	<ul style="list-style-type: none"> ● Do not have the suspended load or the hand chain caught on other structures. ● Do not have the hoist or Trolley hit against stoppers or other structures. 	
<ul style="list-style-type: none"> ● Do not use Trolley with the warning label attached to the body removed or left unclear. ● Do not operate Trolley with other powers than pulling by hand. 		

Do not operate or move Trolley with the hand chain hooked on or around other structures.

- Stop lifting once when the load chain becomes tense.
- In lifting one load with two Trolleys, each Trolley's rated load should exceed the load to be lifted.
- Make sure that the range of lift of the hoist is sufficient for the intended work.



4. MAINTENANCE, INSPECTION AND MODIFICATION



WARNING

- Do not use Trolley if the wheels are rusty.
- Do not use Trolley if the side plates are deformed or bolts and nuts or other parts are broken.



- Never use parts other than genuine ones made by us.

- Only specialists authorized by the employer may carry out the maintenance, inspection or repair.
- Carry out the maintenance, inspection or repair with Trolley unloaded (i.e. without load).
- When any disorder is found in the maintenance or inspection, immediately make repair before re-operating Trolley.



CAUTION

- Whenever carrying out the maintenance, inspection or repair, set up a warning plate indicating 'Under Working' ("UNDER INSPECTION" etc.).



Note: For inspection that requires overhauling, please consult specialists or your nearest distributor of our products.

5. HOW TO ADJUST TROLLEY TO THE RAIL WIDTH OF I-BEAM (G, P, GE and PE types)



WARNING

- Trolley should be assembled and operated only by those who are familiar with the contents of the manual and instruction labels.



- The rail (I-beam) on which Trolley is installed is to bear loads more than 5 times the rated load.
- Wrong placing of adjustment collars or washers is very dangerous. Not fastening the bolts of Key Plate is also very dangerous. Properly assemble Trolley following the assembly procedures mentioned below.



5-1. HOW TO ADJUST WASHER-TYPE ADJUSTABLE TROLLEY TO RAIL WIDTH (G type and P type)

Table 1 RAIL WIDTH AND THE NUMBER OF ADJUSTMENT WASHERS (EXAMPLE)

Rated Load (ton)	Rail Width (mm)	Upper row : The number of washers to be put on both sides of connector											
		Lower Row : Rail width of I-beam (mm)											
		One Side	One Side	One Side	One Side	One Side	One Side	One Side	One Side	One Side	One Side	One Side	One Side
0.5 · 1	60 ~ 130	0	0	2	2	6	6	10	10	11	11	—	—
		60		75		100		125		130			
1.6 · 2	70 ~ 155	0	0	0	0	4	4	8	8	12	12	13	13
		70		75		100		125		150			155
2.5 · 3 · 3.15	90 ~ 160	0	0	1	1	5	5	9	9	11	11	—	—
		90		100		125		150		160			
5	90 ~ 180	0	0	1	1	5	5	9	9	11	11	13	13
		90		100		125		150		160			180
7.5 · 8 · 10	125 ~ 190	0	0	4	4	8	8	9	9	10	10	—	—
		125		150		175		180		190			
15 · 16 · 20	150 ~ 190	0	0	4	4	6	6	—	—	—	—	—	—
		150		175		190		—		—			—

Note: When you use I-beam with larger rail widths than listed above, we suggest that you use Trolley higher in capacity by one class for safety.

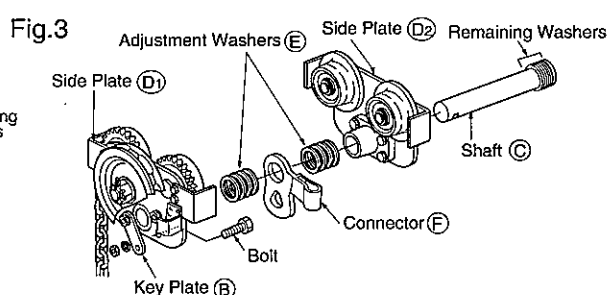
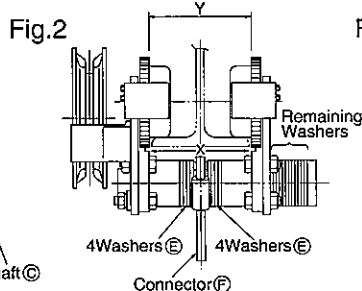
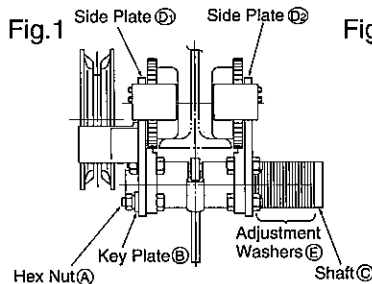

- (1) Each Trolley is shipped after being adjusted to fit the minimum rail width shown in Table 1. If you need another width, make an adjustment in the following procedures.
- (2) Remove Hex Nut (A) to remove Key Plate (B).
- (3) Pull out Shaft (C) from between Side Plates (D1) and (D2) as shown in Fig.3.
- (4) Pull out the required number of Adjustment Washers (E) from Shaft (C).
* Do not lose them as they are needed.
- (5) Select a rail width you require in Table 1, and insert the required number of Adjustment Washers (E) on both sides of Connector (F) evenly as shown in Fig.2.

Note: Trolley width can be adjusted by 25 mm by placing 4 pieces of Adjustment Washers (E) on one side and 4 pieces on the other side, 8 pieces in total. Wrong placing of the Washers (e.g. not equal number on both sides) or loose nuts causes accidents like a fall of Trolley.

- (6) Ascertain the number of Adjustment Washers inserted, and that the clearance between the Trolley wheels and the rail width X is less than the distance of rail width X to which 6 mm is added.
- (7) Insert Side Plate (D2), put Key Plate (B) and fasten Hex Nut (A).
- (8) Put the remaining Adjustment Washers on Shaft (C) (outside the side plate) and fix them with a split pin.

5-2. HOW TO ADJUST COLLAR-TYPE ADJUSTABLE TROLLEY TO RAIL WIDTH (G, P, GE and GP types)

- (1) Each Trolley is shipped after being adjusted to fit the minimum rail width shown in Table 2. If you need another width, make an adjustment in the following procedures.
- (2) First, remove Split Pin (G) in Fig.4.
 - ※ Do not break Split Pin as it is used again at the end of adjustment work.
- (3) Draw out Adjustment Collars (E) from Shaft (C).
 - ※ Do not lose them as they are needed.
- (4) Remove Hex Nut (A) to remove Key Plate (B). Draw out Side Plate (D2) and Connector (F) from Shaft (C).
- (5) Select a rail width you require in Table 2, and insert the required number of Adjustment Collars (E) on both sides of Connector (F) evenly as shown in Fig.5.

Table 2

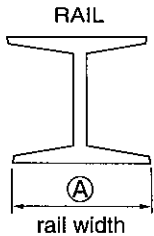

RAIL	Number of collars (E)			
	0	2	4	
	Rail width			
	(A) Rail width (mm)			
GE-0.5 · G-0.5 · PE-0.5 · P-0.5	0.5t	75	100	125
GE-1 · G-1 · PE-1 · P-1	1t	75	100	125
GE-1.6~2 · G-1.6~2 · PE-1.6~2 · P-1.6~2	1.6t · 2.0t	100	125	150
GE-2.5-GE-3-GE-3.15-G-2.5-G-3-G-3.15-PE-2.5-PE-3-PE-3.15-P-2.5-P-3-P-3.15	2.5t · 3t · 3.15t	100	125	150
GE-5 · G-5 · PE-5 · P-5	5t	125	150	175
GE-7.5-GE-8-GE-10-G-7.5-G-8-G-10-PE-7.5-PE-8-PE-10-P-7.5-P-8-P-10	7.5t · 8t · 10t	150	175	—

For Trolleys over 15 ton, refer to catalog specifications. Or any width will be available at your request.

⚠ WARNING

• Wrong placing of Adjustment Collars (e.g. not equal number on both sides) or loose nuts causes accidents like a fall of Trolley. Trolley width can be adjusted or widened by 25 mm by placing one collar on both sides of Connector.



Fig.4

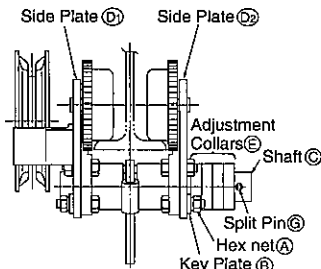

Fig.5

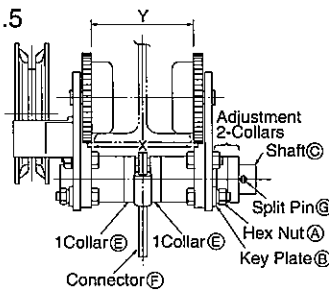
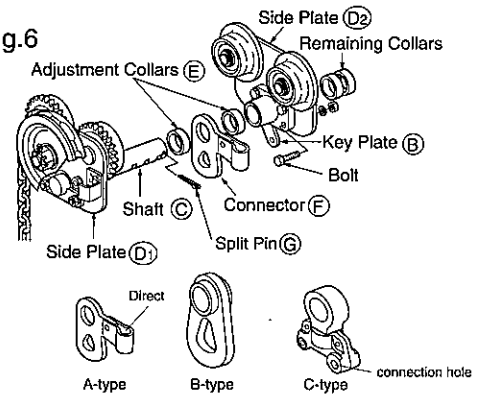

Fig.6



- (6) Ascertain that the clearance between the Trolley wheels and the width of the rail used is suitable.
- (7) Insert the drawn Side Plate (D2), put Key Plate (B) and fasten Hex Nut (A).
- (8) Put the remaining Adjustment Collars on Shaft (C) (outside the side plate) and fix them with Split Pin (G).
 - ※ Tighten all bolts perfectly.

CONNECTORS [to connect Trolley to hoist]
 (Applicable to both Geared and Plain Trolleys)
 A-type (0.5-2 t): Hook connection and direct connection
 B-type (3-5 t): Hook connection only
 C-type (3-5 t): Direct connection only

Note1: For GE type and PE type Trolleys (0.5-5t), usable is only A-type (forging).

Note2: For direct connection to hoist, see IX.

5-3. WHEN YOU USE αP TYPE PLAIN TROLLEY [to be connected to electric hoist] (COLLAR-TYPE) HOW TO ADJUST αP TYPE PLAIN TROLLEY TO RAIL WIDTH

• PLAIN TROLLEY, rated load 60 kg -500 kg

- (1) Each Trolley is shipped after being adjusted to fit the minimum rail width shown in Table 3. If you need another width, make an adjustment in the following procedures.
- (2) First, remove Split Pin (G) in Fig.7.
 - ※ Do not break Split Pin as it is used again at the end of adjustment work.
- (3) Draw out Adjustment Collars (E) from Shaft (C).
 - ※ Do not lose them as they are needed.
- (4) Remove Hex Nut (A) to remove Key Plate (B). Draw out Side Plate (D2) and Connector (F) from Shaft (C).
- (5) Select a rail width you require in Table 3, and insert the required number of Adjustment Collars (E) on both sides of Connector (F) evenly as shown in Fig.8.

Table 3 The number of Adjustment Collar to be put on both sides of Connector

Unit : Piece(s)

Rail Width	50 mm		75 mm		100 mm		125 mm	
	one side	one side	one side	one side	one side	one side	one side	one side
PLAIN TROLLEY	0		1	1	2	2	3	3
			2		4		6	

⚠ WARNING

• Wrong placing of Adjustment Collars (e.g. not equal number on both sides) or loose nuts causes accidents like a fall of Trolley. Trolley width can be adjusted or widened by 25 mm by placing



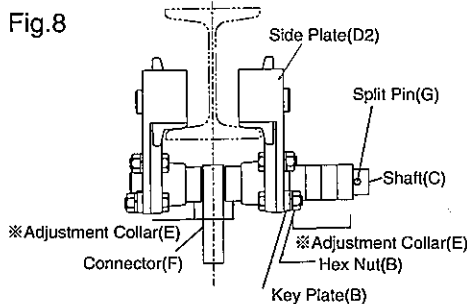
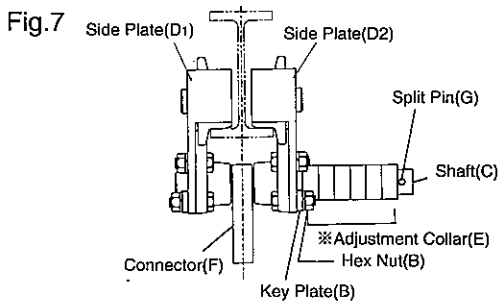

- (6) Ascertain that the clearance between the Trolley wheels and the width of the rail used is suitable.
- (7) Insert the drawn Side Plate (D2), put key Plate (B) and fasten Hex Nut (A).
- (8) Put the remaining Adjustment Collars on Shaft (C) (outside the side plate) and fix them with Split Pin (G).
- (9) Hook the top hook of Model α electric hoist on to Connector of Trolley.

5-4 How to adjust the alpha type plain trolley respectively to the I-beam rail (WASHER-TYPE)

- Adjustment of the plain trolley for the rated load of 60kg~500kg

Table4 Numbers of adjusting washers to be fitted inside of the side-plates.

Rail width of I-beam	50mm (2 in)	57.15mm (2 1/4 in)		76.2mm (3 in)		82.55mm (3 1/4 in)		101.6mm (4 in)		127mm (5 in)		(pieces)	
		Plain trolley	0	one side	other side	one side	other side	one side	other side	one side	other side		one side
			1	1	4	4	5	5	8	8	12	12	24-26 washers in total
			2		8		10		16		24		

※Someone products have 2 more washers than the number specified in Table 4 depending on the deviation in thickness. For rail widths of 100mm (for plain trolley) and 125mm (for electric trolley and plain trolley) one additional washer should be fitted on either one side or both sides. Pay attention that the clearance between wheels and the rail (distance between the rail and the wheel rim on the other side when the wheel is pushed against one side of the rail) should not exceed 5mm. Washers are not always to be inserted.



WARNING

Do not lose adjusting washers, as they are put in equally on both sides of the side-plates. If washers are not equally inserted on either side, the grooved nut and the bolt are not in order, possibly causing an accident.



5-4-1 How to adjust the trolley to the rail width of I-beam

- (1) Each trolley is delivered after it has been adjusted to the minimum size, namely the rail width of I-beam specified in Table 4. When other rail widths than those shown in Table 4, adjust the trolley in the following procedure.
- (2) First take out bolt and nut shown in fig.9.
 - ※Do not lose the removed bolt and nut, as they are to be refitted after adjustment.
- (3) Remove adjusting washers (C) from the suspension shaft.
 - ※Do not lose the washers, as they are to be reassembled afterwards.
- (4) Find a rail width of I-beam as per Table 4 for which the trolley is to be adjusted and fit corresponding numbers of adjusting washers (C) to the outside of the connector as Fig.10 shows.

Fig.9

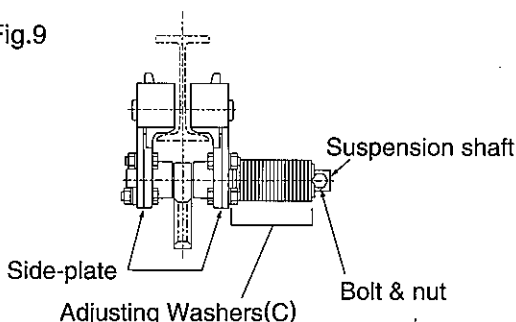
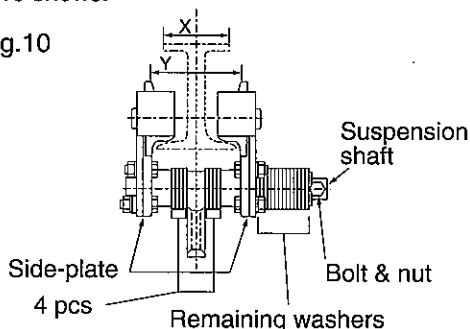

Fig.10



WARNING

• When adjusting washers are erroneously inserted in one side only or bolt & nut are not sufficiently tightened, the trolley may happen to fall down, causing a heavy accident. A trolley width up to 25mm can be adjusted with 8 pieces of adjusting washers which are to be equally inserted in both sides, namely 4 pieces on each side.



- (5) Make sure that a correct clearance is kept between the rail and the wheel. The clearance should be fundamentally adjusted with the number of adjusting washers as per Table 4 but it may be required to make a fine adjustment with more or less washers to keep the clearance between X and Y within 5mm, since the rail width may vary depending on steel manufacturers.
- (6) Fit the side-plate and insert remaining washers on the suspension shaft.
- (7) Fully tighten bolt & nut on the outside of washers.
- (8) Hang the top hook of the alpha type chain hoist on connector of the trolley to operate the chain hoist.

II) CAUTION ON INSTALLING TROLLEY

⚠ WARNING • When adjusting the width, be sure to insert Adjustment Collars equally on both sides of the connector. **!**

Inserting the collars together on one side only may unevenly load the trolley, causing an accident of its malfunction or falling down.

1 How to fit Trolley to the traversing rail

- Trolley can be fitted to the rail, being adjusted to several different widths of the traversing rail by shifting Adjustment collars only.
- Insert the same number of pieces of Adjustment Collars on both sides of Connector of Trolley.
- Avoid improper setting shown in Fig.11 (marked with X) which may result in serious accidents.

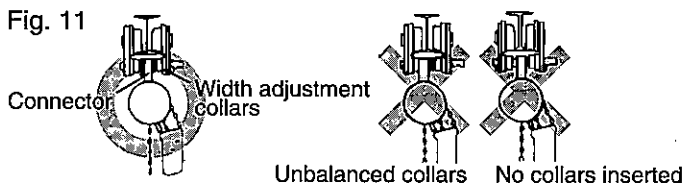

2 How to fit Trolley to the curved traversing rail

- (1) In the case that geared Trolley with hoist is fitting to the curved traversing rail, its hand chain wheel side should be outside the rail curve.
- (2) If it is inside the rail curve, the traversing rail or the wheel gear of the trolley may be possibly damaged.
- (3) In the case that the traversing rail has curves in both right and left directions, the trolley should be fitted in such a manner that the above-mentioned instructions apply to a smaller curve (Refer to Fig.12).

Fig. 12 With geared trolley

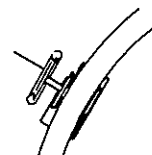

3 Traversing rail and stoppers

⚠ WARNING • For avoiding eventual falling of Trolley, mount a stopper at the rail ends. **!**

• Avoid stopping Trolley by hitting it against a stopper.

A portion of the traversing rail contacting trolley wheels should not be painted but be polished when it is rusted.

- Joints of the traversing rail
- (1) Joints of the traversing rail should be located in the vicinity of supports for the rail.
- (2) In the case that a backing plate is welded on the side or bottom of the rail (See Fig.13), a plate with suitable thickness must be selected.
- ※ If too thick a plate is attached, Trolley will hit it and be unable to pass through the point in the worst case.
- (3) Staggered joints must be aligned within 0.5 mm in both horizontal and vertical directions. The portions on which the trolley wheels travel should be finished by a grinder (See Fig.14).

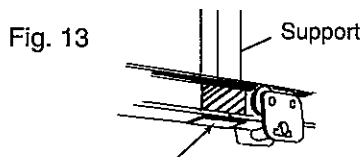

Pay attention to the thickness of backing plates.

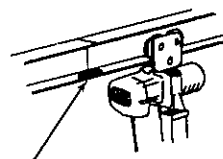
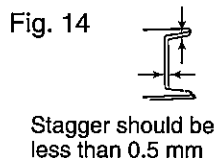

Rail joints should be finished by grinder.

• Anti-falling stoppers at the rail ends

- (1) For avoiding that Trolley hoist will hit a wall, etc. even when it hits the stoppers with a higher speed or the hoist swings, a distance (a) shown in Fig.15 should be sufficiently wide.
- (2) The stoppers should be firmly secured so as to withstand the impact and be covered with a shock-absorbing material like rubber, etc. (See Table 5 · Fig.18)
- ※ Avoid such installation and operation as Trolley always stops by running against the stopper. Do not pull the push-button cord. Do not traverse Trolley by pulling the push-button cord (Fig.16).

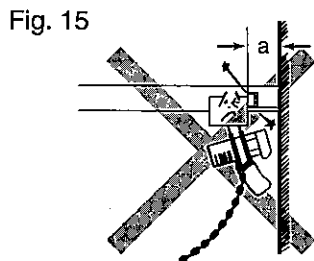

Fig. 16 Undue burden on a cord

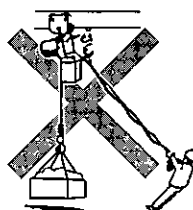
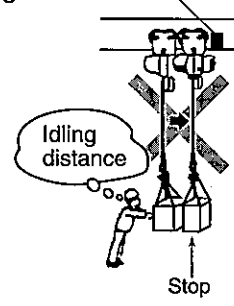

Fig. 17 Stopper



• Stop Trolley before it hits against the stopper.

- (1) On controlling the traversing of Trolley, operate Trolley so as to stop Trolley of itself before it hits against the stopper (Fig.17).

Table 5 Stoppers

Dimension of the traversing rail (mm)	150×75 200×100	250×125	350×150	450×175
Angle steels (mm)	L50×50×6	L65×65×6	L75×75×6	L90×90×7
A (mm)	20	30	35	45
B (mm)				

Fig. 18

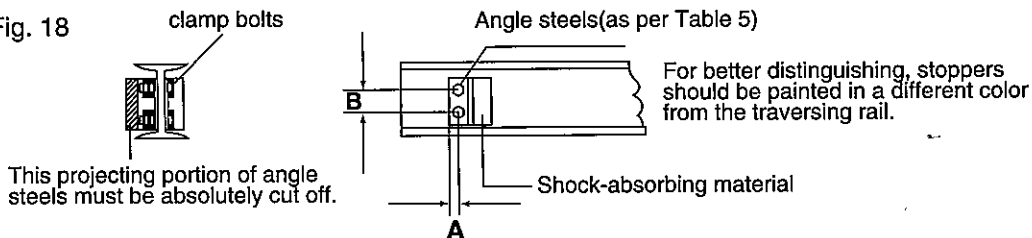

III) DAILY INSPECTION

- For daily operation, be sure to carry out the following check prior to operation.
- In cases of any abnormality, stop operating the unit and take proper countermeasures before using it again.
- Consult a dealer of our products when it is not possible to take proper measures.
- ※As to details refer to the operation manual of the chain hoist.

IV) Monthly inspection

- Carry out the voluntary inspection more than once in a month.
- If there is any abnormality discovered by the inspection, take appropriate measures against it.
- ※As to details refer to the operation manual of the chain hoist.

V) Annual inspection

- Carry out the voluntary inspection more than once in a year.
- If there is any abnormality discovered by the inspection, take appropriate measures against it.
- ※As to details refer to the operation manual of the chain hoist.

VI) PROCEDURES FOR MAINTENANCE AND INSPECTION



WARNING

- Before doing maintenance, inspection and repair work, be sure to switch OFF the power source.



- Maintenance, inspection and repair work should be done by persons with specialized knowledge, or else, you should ask a dealer of our products.
- Make it a rule to carry out maintenance, inspection and repair in non loading (hoisting no loads) condition.
- If any abnormality is found in the maintenance and inspection, do not use the unit.

※As to details refer to the operation manual of the chain hoist.

• Bent side-plates

- Two side-plates should be free from deformation.
- The angle shown in Fig.19 should be right angle.
- Supply oil if there is abnormal sound caused by lack of oil in making traverse movement.
- There should be no missing or looseness of the bolts, nuts, etc.
- The wheel with gear cut on it should not have dust in the geared portion.

• Wear of trolley wheels

Trolley wheel as described below should be replaced with new one.

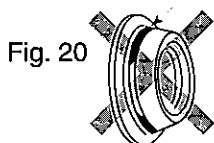

Fig. 20 There is such a visible, obvious gap in the portion which is in contact with the edge of I-beam.

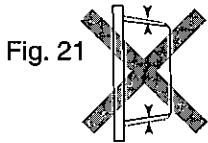

Fig. 21 The wheel gets more than 5% wear-out from the original configuration.



Fig. 22 The wheel having partial wear on the tread surface (visible degree).

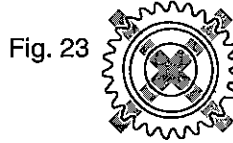

Fig. 23 The gear of geared wheel has been worn out and/or damaged in visible degree.

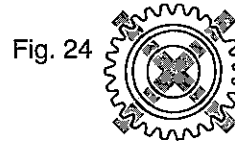
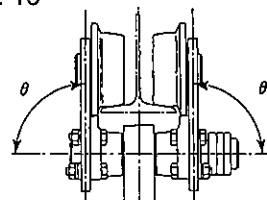

Fig. 24 A tooth or some teeth of the geared wheel have been broken off

Fig. 19



VII) HOW TO MOVE TROLLEY-HOIST (Trolley and Hoist Combination)

1. PLAIN TROLLEY

- If you wish to move Plain Trolley-Hoist when there is no load on the hoist, pull the load chain in the required running direction, and Trolley will move smoothly.
- When there is a load on the hoist, push the load from behind and in the required running direction. Never try to pull the load with the load chain or hand chain as it is very dangerous.

2. GEARED TROLLEY

- Operate Trolley by means of the hand chain of Trolley. Even if the hand chain itself is pulled in the running direction, Trolley will not move due to the gearing.
- Pulling the load sideways too sharply makes Trolley run erratically and deforms Connector, Side Plates, wheel shaft, bracket, etc., and it is dangerous, therefore it is necessary to take care in this regard.

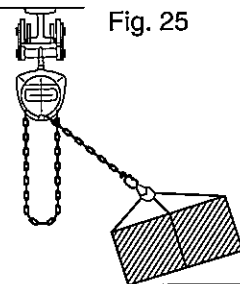

Fig. 25

VIII) CARE AND MAINTENANCE AFTER USE

The closed-type ball bearings are used in the wheel shaft and require no oiling. But the pinion on Geared Trolley has to be oiled occasionally.

1. Storing of Trolley-Hoist

Never leave the machine exposed to the rain or dew and do not store it in damp conditions.

2. Periodical Inspection

Check for the following periodically within a month.

- Cracks or abrasion of wheels
- Cracks in hand chain wheel of geared trolley
- Burning of pinion gear and bearing metal
- Bend of side plates and wheel shafts
- Looseness of tightening bolts and nuts
- Abrasion and deformation of connector
- Cracks on bracket

After all the above are carefully inspected, wash down the machine and oil it if necessary.

Fig. 26

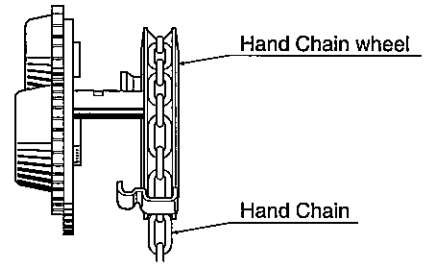

IX) DIRECT CONNECTION OF TROLLEY TO CHAIN HOIST

- You can connect Trolley direct to chain hoist by removing the top hook of hoist. By so doing, you can obtain a shorter minimum distance of Trolley-Hoist height.
- The connection work should be performed only by the experienced technician.
- Model HM-III chain hoist cannot be connected direct to Trolley.
- When connecting an electric chain hoist to Trolley, please refer to the instruction manual of the electric chain hoist.

Fig. 27

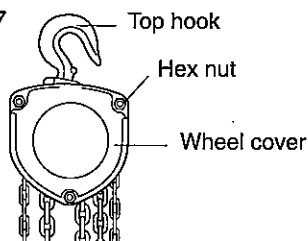

Fig.27 Remove Hex Nuts and remove Wheel Cover.

Fig. 28

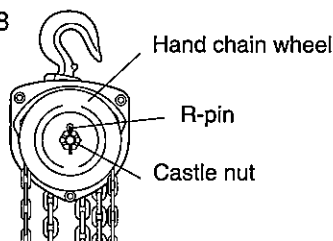

Fig.28 Remove R-pin and Castle Nut, and remove Hand Chain Wheel.

Fig. 29

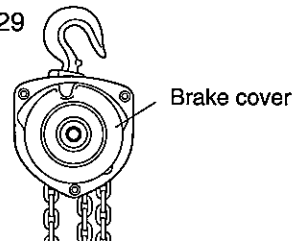

Fig.29 Remove Brake Cover.

Fig. 30

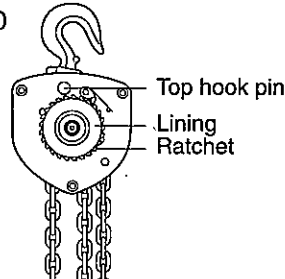

Fig.30 Draw out Top Hook Pin, and remove Top Hook. Leave Ratchet carefully as it is.

Fig. 31

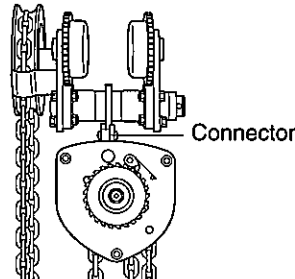

Fig.31 Insert Trolley's connector (direct connection hole) to where hoist's top hook was positioned, and insert Top Hook Pin.

Fig. 32

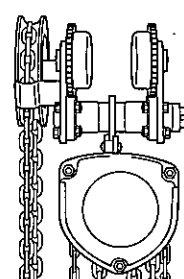

Fig.32 Put back Brake Cover, Hand Chain Wheel, Castle Nut, R-pin, Wheel Cover and Hex Nuts in order.

Fig.31 [Note: Setting should be done so that the hoist's load chain with bottom hook is on the side where trolley's hand chain hangs.]

1. CAUTION IN DOING CONNECTION WORK



CAUTION

- Make sure that Ratchet and Pawl or Pawl Spring are properly positioned.
 - Make sure that the mechanical brake functions properly after Hand Chain Wheel is put.
- To make sure the above, refer to the check points on 2.



2. IMPORTANT CHECK POINTS

Do Correct Assembly Work.



CAUTION

- Direct connection work can be done without disassembling the brake part such as Ratchet or Linings. If the brake part is disassembled by mistake, reassembly should be done with the utmost care, otherwise the brake may not function properly causing accidents. Reassembly work should strictly be done following the procedures mentioned below.



- Make sure that Disc Hub is set down to the bottom thread part of Pinion Gear leaving no clearance. (Fig.33)
- Make sure that Ratchet and Linings are placed in the right position. (Fig.33)
- Make sure that Pawl Spring is properly set with Pawl, and that Pawl is properly set with Ratchet. Setting is all correct if Pawl goes clattering around Ratchet teeth when Ratchet moves clockwise, and if Pawl stops the rotation of Ratchet when Ratchet tries to move anticlockwise. (Fig.34)

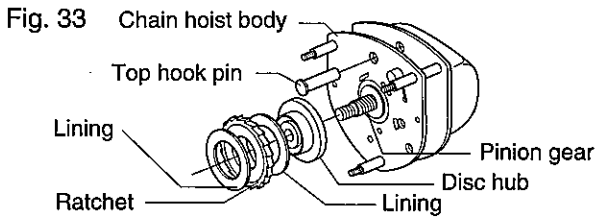
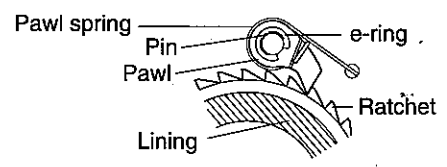



Fig. 34 Make sure that Pawl Spring is properly set with Pawl.



3. CAUTION FOR BRAKE ADJUSTMENT

- (4) Make sure that Hand Chain Wheel is set down properly to the bottom of Pinion Gear. If the beginning of the thread of Pinion Gear is seen at the center hole of Hand Chain Wheel, it is the right position. (Fig.35)
 - (5) Put Castle Nut on to Pinion Gear. Putting this part correctly is important for braking. Fasten Castle Nut by hand, and then loosen it as little as possible until the slot of Castle Nut and the hole of Pinion Gear meets; the first meeting is the right position. And then insert R-pin. (Fig.36)
- After putting R-pin, try to move Hand Chain Wheel to the lowering direction. If it is too heavy because of the friction of Linings, remove R-pin, and loosen Castle Nut until the next meeting of the slot and hole, and put R-pin again. Important is that Castle Nut should never be placed loosely.
 Lastly, lift a light load of 10 - 50 kg. Then if the clearance between Hand Chain Wheel and Castle Nut is around 0.5 mm, it is the right assembly.

Note: In case there is a check washer like  between Hand Chain Wheel and Castle Nut, place it so that the  part of the check washer comes to about the center as shown in Fig. 37.

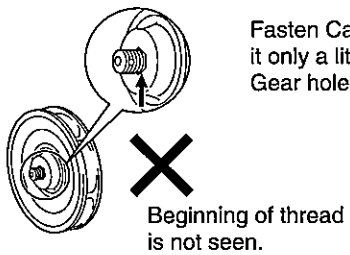
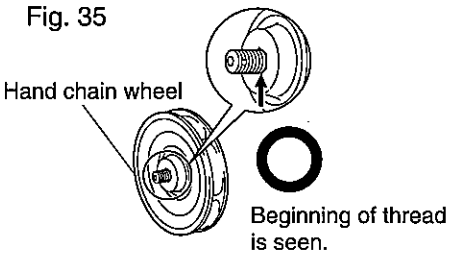

Fasten Castle Nut by hand, and loosen it only a little till Castle Nut slot and Pinion Gear hole meets.

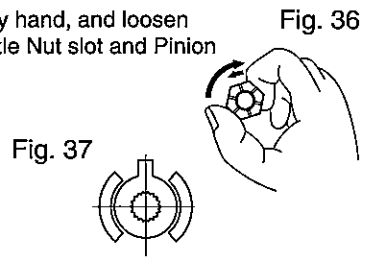

EC declaration of conformity

In compliance with the EC Machinery Directive 89/392/EEC, Annex II A

We hereby confirm that due to its design and construction and in the type marketed by us the machine designated below conforms with the pertinent essential safety and health requirements of the relevant EC Directive.

In case of a modification of the machine which is not agreed with us, this declaration is no longer valid.

Designation of the machine : Geared Trolley or Plain Trolley
 Types : GE-0.5~GE-31.5 G-0.5~G-31.5 PE-0.5~PE-20
 P-0.5~P-20 αP-006~αP-05
 Pertinent EC Directives : EC Machinery Directive(89/392/EEC)
 version 91/368/EEC, 93/44/EEC, 93/68/EEC

Used harmonized standards, especially : ISO 9001-1994(Certificate Number JQA-1547)
 JIS B 8802

Date/signature of manufacturer : 10.4.1998

Information on the signer : 
 (K. TSUDA)
 Director, Technical Division

The goods have passed rigid inspection by us ahead of delivery in accordance with our standard in terms of test load and all other respects in good and satisfactory condition.

INSPECTOR T. Uesugi



ELEPHANT CHAIN BLOCK CO., LTD.

180, Iwamuro 2-chome, Osaka-Sayama-shi, Osaka, 589-8502 JAPAN

Phone : 072-365-7778 Fax : 072-365-7869